



User Manual v.5.1

MuoviPro

Portable bioelectrical signal amplifier



Read this manual carefully before using MuoviPro

1	GENERAL DESCRIPTION	5
2	MUOVIPRO KIT CONTENT	6
3	END USER.....	6
3.1	Contraindications	7
3.2	Side effects	7
4	SAFETY PRECAUTIONS AND OTHER WARNINGS	7
5	SYMBOLS USED ON MUOVIPRO AND IN THE USER MANUAL	9
6	TECHNICAL SPECIFICATIONS.....	11
7	DETAILED DESCRIPTION	14
7.1	Muovi probe - Controls, indicators, and connectors.....	14
7.1.1	Input connection port and charging	15
7.1.2	ON/OFF button	16
7.1.3	LED indicators	16
7.1.4	Patient Ref connector	18
7.2	SyncStation - Controls, indicators and connectors.....	18
7.2.1	Connectors.....	20
7.2.2	LED indicators	21
7.2.3	Controls	22
8	USE OF MUOVIPRO	23
8.1	Use of the Muovi probe.....	23
8.1.1	Muovi probe WiFi interface	23
8.1.2	Signals.....	24
8.1.3	Acquisition electrodes and patient connection	28
8.1.4	Recharge of the Muovi probes	30
8.1.5	Wireless data transfer	31

8.1.6	Muovi internal web page.....	31
8.1.7	Probe Nomenclature	35
8.2	Use of the SyncStation	36
8.2.1	SyncStation network interface	36
8.2.2	Data transfer to PC	37
8.2.3	SyncStation internal web page	44
9	TROUBLESHOOTING.....	47
10	MUOVIPRO MAINTENANCE AND STORAGE	48
11	RISK ANALYSIS	49
11.1	General requirement for basic safety and essential performance CEI EN 60601-1-2	49
12	INTENDED USE	52
13	TECHNICAL CHARACTERISTICS.....	53
14	WARRANTY.....	54
14.1	Warranty conditions.....	54

1 GENERAL DESCRIPTION

The MuoviPro is an instrument made up of 4 wireless probes (Muovi) and a charging synchronisation base (SyncStation). The Muovi probes are wireless amplifiers with 32 channels on each one that are miniaturized and wearable devices, designed to acquire 128 bioelectrical signals. The Muovi probe is able to detect surface electromyographic signals (HD-sEMG) and electroencephalographic signals (EEG). Each probe performs amplification, filtering, digital conversion and then wireless transfer of the acquired signals to the PC, for real-time viewing and archiving.

The Muovi probe doesn't require adapters for the connection of the recording electrodes, the grids in fact are connected directly to the instrument.

The SyncStation recharging and synchronisation base manages the connection of several Muovi probes at the same time and also has four auxiliary inputs available.

On the website <https://otbioelettronica.it/downloads>, freeware software is available for viewing and archiving in real time of the bioelectrical signals, called OT BioLab+, designed by OT Bioelettronica.

The MuoviPro is a system designed for clinical research, carried out by qualified researchers and is completely safe for the patient. Safety is achieved by meeting the design requirements for devices with an electronic part applied to the patient.

2 MUOVIPRO KIT CONTENT

- 4 Muovi probe with 32 channels;
- 1 SyncStation;
- 1 Ethernet cable;
- 1 AC power supply (36W 12V);
- 1 Conductive cream package;
- 4 Reference strap for the wrist;
- 4 Reference strap for the ankle;
- 4 Reference cable;
- Array and matrices of electrodes of different sizes, depending on the customer request;
- 1 MuoviPro user manual.

3 END USER

MuoviPro allows non-invasive recording of biopotentials (sEMG, EEG) detected by superficial electrodes. The end user must be familiar with the technique and have received proper training in EMG or EEG detection and interpretation. Consequently, it is intended to be used primarily as a laboratory device, secondly it can be used in the physiotherapy outpatient setting to evaluate muscle activity in a qualitative and quantitative manner.

The user should be a specialised operator:

- a) Minimum knowledge and basic notions of the human body
- b) Understanding of the Italian and/or English language
- c) Minimum training for the use of the device
- d) Permissible impairments:
 - maximum hearing reduction of 40% with residual hearing at 60%
 - 40% vision reduction with 60% residual vision

The patient should be:

- a) Age: >15 Years
- b) Weight: not relevant
- c) Health: free of cardiological problems and not a pacemaker wearer
- d) Nationality: indifferent

3.1 Contraindications

MuoviPro has no particular contraindications when used jointly with personal computers, provided that all the electrical devices connected to it comply with the safety rules and standards concerning grounding and leakage currents.

3.2 Side effects

No significant side effects are known. The materials used for manufacturing all the parts in contact with the patient are biocompatible. Possible slight cutaneous allergic reactions (e.g., skin reddening) are reduced to a minimum by reducing the duration of bioelectrical signal acquisitions.

4 SAFETY PRECAUTIONS AND OTHER WARNINGS

The use of the MuoviPro system is absolutely forbidden in the following conditions:

- While other monitoring devices are in use with the patient.
- While electro surgery equipment, short wave or microwave therapy devices are being used.
- By mentally impaired people.
- Whenever the equipment is damaged.
- In proximity of inflammable substances (especially inflammable liquids and gases) or in environments with high concentration of oxygen.

- On patients carrying life-supporting equipment that might be adversely affected by electromagnetic interferences, such as pacemakers, etc.

The following precautions should be observed:

- Only use electrodes supplied by the manufacturer: MuoviPro is guaranteed to achieve tested performance only if used with electrodes supplied by the manufacturer.
- Contact the manufacturer immediately if extraneous materials permeate into the device (liquids, powders, etc.). In case of strong impacts (like dropping on the floor, etc.), verify that no crack or any other kind of damage is visible. If in doubt, please contact the manufacturer.
- The MuoviPro is subject to electromagnetic interference that is not dangerous for the patient (such as electrostatic or electromagnetic interference generated by electrical motors and other sources). This interference may affect the measurements of the physiological variables derived from the EMG or EEG signals. These measurements are not meant to be used for diagnostic purposes, and thus these signal alterations cannot be dangerous for the patient, please always take into account the presence of noise in your signal processing tasks and evaluations.
- The connection between MuoviPro and other electrical devices must be done in compliance with the European standard EN 60601-1-1 on medical devices.
- The use of the MuoviPro is restricted to skilled personnel.
- Incorrect measurements can arise when unskilled personnel use the device in presence of strong sources such as electromagnetic interference (e.g., strong electromagnetic fields). The presence of interference in the signals is easily recognised by skilled personnel. Read carefully the instruction remarks before use.



The device must not be used in any other way than indicated in these instructions.

5 SYMBOLS USED ON MUOVIPRO AND IN THE USER MANUAL



Serial number



Indicates the manufacturer's catalogue number so the medical device can be identified



Identifies a type B applied part complying with IEC 60601-1



Manufacturer



Do not dispose of this product as non-differentiated waste. Prepare the re-use or separate collection of the product Union on the disposal of electrical and electronic equipment in compliance with the Directive 2002/96/CE.



CE marking indicates that product complies with applicable European Union regulations



Read the instruction manual



Indicates a medical device that should not be used if the package has been damaged or opened



Indicates the temperature limits to which the medical device can be safely exposed



Indicates the range of humidity to which the medical device can be safely exposed



Indicates the range of atmospheric pressure to which the medical device can be safely exposed



Indicates that natural rubber latex was not used in the manufacture of the product, its container or packaging.

RoHS

Indicates that the electronic equipment is in compliance with the RoHS Directive on the restriction of the use of hazardous substances

Degrees of protection:

IP20

Protected against solid objects over 12.5 mm

No protection against liquid

12VDC – 36W

Indicates that the equipment is suitable for direct current only, to identify relevant terminals with indication of nominal voltage and power supply.

Model: MuoviPro x

Variants: x = 32: 32 channels (OT0130A), x = 64: 64 channels (OT0130B), x = 96: 96 channels (OT0130C), x = 128: 128 channels (OT0130D)



Read carefully the instruction remarks before use

6 TECHNICAL SPECIFICATIONS

MuoviPro is a battery-operated device, designed to ensure a high level of safety for the patient and the operator in all conditions of use. Isolation between the MuoviPro device and the PC for displaying and recording real-time data is inherently achieved via wireless data transfer. The single connector available on each Muovi probe is used either for the interface with acquisition electrodes (electrode array) or for battery charging. This prevents the possibility of powering the Muovi probe from an external source while it is connected to the patient for bioelectrical signal sampling.

The auxiliary input connectors on the SyncStation base offer the possibility to connect other mobile devices (goniometers, accelerometers, or amplifiers for other biological signals). This connection must be made in accordance with the European standard EN 60601-1-1 on medical devices. Table 6.1 shows a list of MuoviPro system versions.

System Configurations	Example of probes connectable to the system
128 channels	Four probes with 32 channels
96 channels	Three probes with 32 channels
64 channels	Two probes with 32 channels
32 channels	One probe with 32 channels

TAB. 6.1: List of available system versions.

The technical specifications of the MuoviPro are shown in Tables 6.2 and 6.3.

MuoviPro	Total number of channels	132
	Maximum number of probes	4
	Selectable sampling frequency	500 o 2000 Hz
Muovi probe	Functions	Acquisition of 32 EMG or EEG signals
	Number of channels	32
	Low pass filter	$\sim F_{SAMP}/4$
	High pass filter	DC coupling or 10 Hz digital filter
	Noise level referred to the input	$< 4 \mu V_{RMS}$
	Input resistance	500 M Ω
	Input range	0 – 3.3 V
	Battery	Battery LiPo 3,7V
	Battery life - Charging times	Turn on/Continuous Trasmitting - 4 hours/2 hours, complete charge - 2 hours and 30 minutes
	IMU	
	Number and type of signals	<ul style="list-style-type: none"> • Triaxial accelerometer (+/- 4g) • Triaxial gyroscope (2000 ° / s) • Triaxial magnetometer
	Data conversion and communication	
	Resolution of the A/D converter	24 bit
	Input dynamic of the A/D converter	$\pm 2.4 V$
	Data transfer to PC	WiFi through TCP socket

TAB. 6.2: Technical specifications of MuoviPro device and Muovi probes.

SyncStation	Functions	Charging of the Muovi probes, data reception hub from 4 Muovi probes, interface to the PC and acquisition of 4 auxiliary signals
	Communication to PC	Ethernet
	Input signals	128 generated by 4 probes and 4 signals acquired from auxiliary inputs
	Output signals	132 digital signals on Ethernet cable
	Auxiliary channels	4 (3 not conditioned - 1 conditioned)
	Supply	12V _{DC} power supply supplied with the system
	Details of the unconditioned auxiliary channels	
	Number of channels	3
	Resolution	16 bit
	Gain	0.5V / V (adapts the input range $\pm 5V$ to the dynamics of the ADC 5V)
	Low pass filter	Not filtered
	High pass filter	Coupled in DC
	Noise level referred to the input	$< 6 \mu V_{RMS}$
	Input range	$\pm 5 V$
	Details of the conditioned auxiliary channel (for load cells)	
	Number of channels	1
	Resolution	16 bit
	Gain	205 V/V
	Low pass filter	15 Hz
High pass filter	Coupled in DC	
Noise level referred to the input	$< 6 \mu V_{RMS}$	
Load cell power supply	5 V	

TAB. 6.3: Technical specifications of SyncStation base.

7 DETAILED DESCRIPTION

The MuoviPro device is a system consisting of 4 battery powered portable probes that are used for the acquisition of surface EMG signals and EEG signals for brain computer interfaces. There is also a charging and synchronisation base called SyncStation, which allows the acquisition of 4 auxiliary channels: 3 on BNC connectors and 1 on a dedicated connector for connection and power supply of a load cell. The signals can be transferred to a PC for real-time data and recording:

- one Muovi probe at a time, using the WiFi network generated by the probe itself
- up to 4 Muovi probes at the same time, by means of an initial transfer of signals wirelessly to the SyncStation base that acts as a wireless hub, and a second wired transfer from the SyncStation base to the PC via an Ethernet cable.

The Muovi probes can then act as WiFi access points, or they can be connected to the network generated by the SyncStation base. In both cases, the Muovi probe has a fixed IP address with which you can reach its web page, using any browser. Through the browser it is possible to configure, control and update the probe's firmware itself. The data transfer to the PC is obtained through a TCP using the SyncStation as a server. A configuration string, sent to the Muovi probe, can set all the acquisition parameters and start the data transfer. The communication protocol is available for custom development with a Matlab demonstration code.

7.1 Muovi probe - Controls, indicators, and connectors

The Muovi probe is a device designed to acquire 32 surface EMG signals through electrode arrays or through a 32-channel EEG brain computer interface cap. In figure 7.1 you can see the probe with the different controls, indicators, and connectors on it.

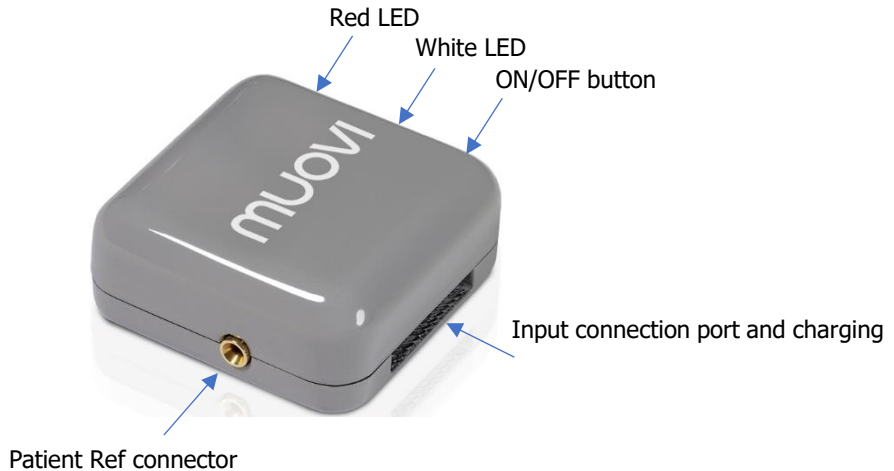

FIG. 7.1: Muovi controls, connectors and indicators.

The Muovi probe can be fully configured via its web page, while the ON/OFF button provides only quick access to basic functions, displayed by LEDs.

7.1.1 Input connection port and charging

The 40-pin input connection port is the interface between Muovi and the electrodes and is also used for charging the internal battery.

The 40-pin connector pinout is available for custom development upon request. Refer to section 8.1.3 for more details on arrays available.

7.1.2 ON/OFF button

This button turns the Muovi probe on and off by completely removing battery power from all of its parts.

7.1.3 LED indicators

Two LEDs have been installed to identify the status of the Muovi. Each one reflects the status of a different device activity:

- 1) the white LED is related to wireless data transfer
- 2) the red LED highlights errors or problems

The two LEDs are independent and the information, provided by each of them, is displayed cyclically for a given number of flashes. Table 7.1 shows the different states and the relative number of LED flashes.

N. flashes	1	2	3	4
White LED	WiFi active	Connected to network	Connected to TCP socket	Data transfer
Red LED	Loss of data during WiFi transfer	-	Low battery level	-

TAB. 7.1: Relationship between number of LED flashes and Muovi probe status

White LED

This LED indicates the status of the WiFi connection and data transfer through a TCP socket.

The white LED provides different information depending on the state of Muovi.

When Muovi is acting as an access point:

- (a) one flash of the white LED indicates that the network has been generated and is available for connection from another device.
- (b) two flashes indicate that a device is connected to the network generated by Muovi.

If Muovi is configured to be connected to the SyncStation's network:

- (a) one flash indicates that Muovi is active and searching for a network;
- (b) two flashes indicate that Muovi has successfully connected to the external network.

Regardless of the role of the Muovi probe, three flashes of the white LED indicate that the probe is connected as a client to a TCP generated by a server device (usually the PC used for viewing and recording real-time data); four flashes of the white LED indicate that the probe is transferring data, via the TCP socket, to a server. When communicating via the SyncStation, the two flashes don't occur, this is because the connection to the TCP socket takes place while the probe connects to the network generated by the SyncStation. If, on the other hand, the probe is connected directly to the PC and the OT BioLab+ software is used, the connection to the socket takes place at the same time as the start of the data transfer, so the white LED switches directly from two flashes to four flashes.

Red LED

The red LED is used to alert the user of an error or critical condition. A single blink of the red LED indicates that samples have been lost during the wireless data transfer, this situation occurs when the internal data buffer of the Muovi is full and data transmission is not possible, acquisition of the next signal sample will create a reset of the internal data buffer with the loss of data, equal to the buffer size (refer to section 8.2 for more details). The red LED will stop blinking, if the above condition is temporary (e.g., the Muovi probe remains too far from the acquisition PC for a limited time) and then the data transfer restarts correctly.

Loss of recorded data can still be verified offline by checking one of the accessory channels (see section 8.2 for more details).

Three flashes of the red LED correspond to a battery level below 20%. Note that there is no priority in error reporting and the last error detected is always displayed, with the corresponding number of red LED flashes.

In general, the low battery level will take priority over the other error conditions, simply because the battery level is monitored more frequently than the other parameters.

7.1.4 Patient Ref connector

The Patient Ref connector, 2mm female banana plug, is the patient reference and should be positioned using either a ground strap (provided in the system kit) or a pre-gelled electrode, placed on the patient's body at a point without electromyographic activity (e.g., wrist or ankle). Ground straps, to ensure good electrical contact with the patient, should be wet. All EMG or EEG signals are acquired as the difference between the potential taken from each electrode and the reference potential, thus generating monopolar signals.

7.2 SyncStation - Controls, indicators and connectors

The MuoviPro system is equipped with a recharging and synchronisation base called SyncStation, shown in Figure 7.2, which is capable of recharging up to 4 Muovi probes simultaneously. Next to the housing dedicated to each Muovi probe, on the SyncStation, there is a LED (see Fig. 7.2) that indicates the charging status of the respective probe. The SyncStation base, as well as being the charging platform for the individual probes, also performs the following functions:

- Synchronisation of the signals received via Wi-Fi from the 4 Muovi probes
- Acquisition of the 4 auxiliary signals, 3 BNC-IN and 1 for load cells

- Trigger signal generation, by pressing the related button (see Fig. 7.2)
- Trigger output through BNC-OUT (see Fig. 7.2)

The controls, indicators, and connectors on the SyncStation base are shown in Figure 7.2 and are described below.

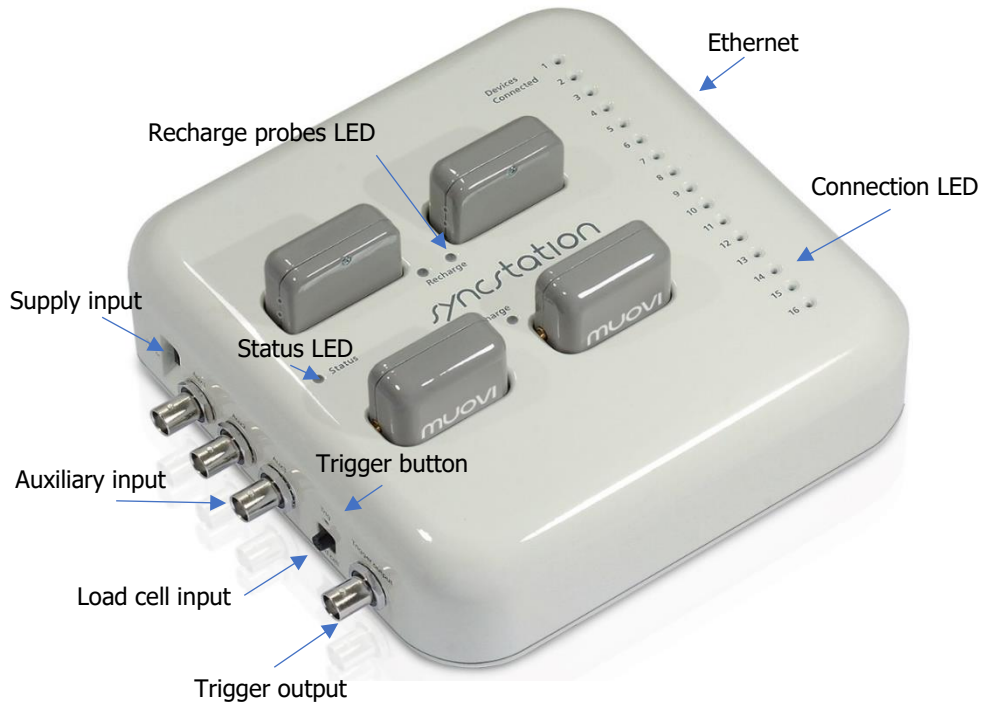

FIG. 7.2: SyncStation controls, connectors and indicators.

7.2.1 Connectors

On the SyncStation there are (with reference to Fig. 7.2): 6 connectors located on the left side, 1 connector located on the right side and 4 connectors located on the upper side:

- Power input: the SyncStation must be powered using the supplied DC power supply (12V_{DC}). The SyncStation turns on automatically when the power cable is plugged in, the ON/OFF switch is not available.
- 3 BNC Auxiliary Inputs: these connectors can be used to acquire externally supplied amplified signals. The input range is ± 5 V and the resolution of the A/D converter used is 16 bit. The three auxiliary inputs work even if no Muovi probe is connected to the base, in this mode the SyncStation can be compared to a 3-channel acquisition board. For the settings of the auxiliary acquisition channels related to the BNCs refer to the OT BioLab+ software user manual.
- Auxiliary input for load cells: in addition to the three generic auxiliary inputs described above there is an additional input dedicated to the connection and to power supply a load cell (signal to be amplified). The connector in question has four contacts and on two of them there is a stabilised 5V supply for the Wheatstone bridge of the load cell. The pinout of the connector is shown in figure 7.3. The channel amplifies the load cell signal with a gain of 205 V/V and filters the low pass signal at 15 Hz.
- Trigger Output: this BNC connector is a digital output (0-5V) that creates the synchronisation signal sent also to the probes connected to the SyncStation via accessible radio frequency signals. This signal can be found in the registration of all the probes connected to the SyncStation and also among the signals of the SyncStation itself. The signal on the BNC can be used to synchronise additional acquisition systems.

- Ethernet: The Ethernet port of the SyncStation can be connected directly to the PC or to a switch/router via an Ethernet cable. This port is used for data transfer from the SyncStation to the PC.
- Charging connector: on the top panel of the base there are 4 slots for charging the Muovi probes, which are inserted into the slots using the input/charging connector.

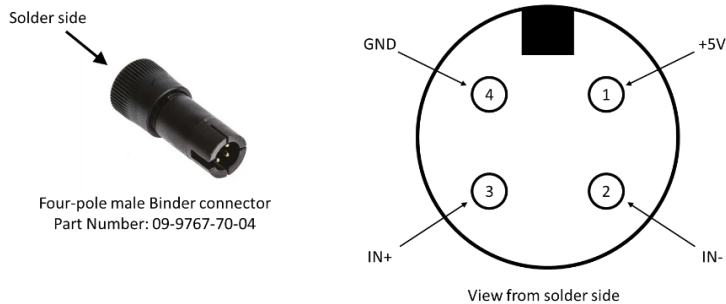

FIG. 7.3: Details on SyncStation load cell connector

7.2.2 LED indicators

To identify the SyncStation base status, probe connection, and probe charging status, 21 LEDs have been installed. Each one reflects the status of a different device activity:

- 1) The three color "Status LED" is related to the status of the base, the LED flashes orange when the SyncStation is starting up, the LED stops flashing and turns steady green, when the application that manages the SyncStation is running. The three color LED turns red in case of an error in the SyncStation operation.

- 2) The 16 "Connection LEDs" indicate the WiFi connection of the associated wireless devices. The SyncStation is designed to be able to receive signals from the four Muovi probes and from additional devices such as the Muovi+, Due+, Sessantaquattro, Sessantaquattro+ and Quattro+ probes. When one of these LEDs lights up, it means that the corresponding device is connected to the SyncStation and is ready to transmit data.
- 3) The 4 "Probe Charging LEDs" indicate the charging status of the Muovi probes when they are physically inserted into the charging slots. The LEDs are on while charging and turned off when charging is complete. When the Muovi probes are inserted into the charging slots they automatically switch off.

7.2.3 Controls

Trigger button: the SyncStation base, during data acquisition, autonomously sends synchronisation pulses to the probes through a radio frequency circuit at intervals of about 5 seconds. The interval between one synchronisation pulse and the next one changes in order to allow the correct alignment of the recordings made. The pulses can however be generated at any time by pressing the trigger button that, in addition to generating a radiofrequency pulse, also generates a digital signal on the Trigger Output BNC.

8 USE OF MUOVIPRO

This manual refers to the use of the MuoviPro system together with the PC running Windows and the free OT BioLab+ software. In case the user wants to use an operating system different from Windows, or if the user wants to customise the interface, documents describing the communication protocol of the MuoviPro system and some samples of MatLab codes are available in the download section of the otbioelettronica.it web site.

8.1 Use of the Muovi probe

8.1.1 Muovi probe WiFi interface

Muovi probes can be used in two ways:

1. Within the MuoviPro system: this is the default mode, which allows you to have multiple probes simultaneously active and synchronised with each other as well as the use of auxiliary channels of SyncStation.
2. Individually, with a direct connection to the PC: this mode allows you to acquire only the signals coming from a Muovi probe without the possibility of synchronisation with other probes or other devices. If a Muovi probe is used inside the MuoviPro system, there is no need to interfere with the WiFi interface, as it is managed in a totally automatic way by the SyncStation. As soon as the probe is turned on, it connects to the SyncStation and it is available to start data acquisition.

If you want to use a Muovi probe directly connected to the PC, you need to start the probe by holding down the power button for 5 seconds. The probe LEDs will start flashing 5 times at the same time and, once the button is released, the probe will generate an open WiFi network, without password, to which you can connect. The name of the generated WiFi network will be "MVXXX-ID", where XXX is the serial

number of the Muovi probe and ID is the identification number of the Muovi probe that can range from 1 to 4. In this mode the Muovi probe acts as a DHCP server providing settings to devices connected to its network, but only one device at a time can connect to the network generated by the Muovi probe. This mode can be configured as the default power mode via the Muovi probe's internal web page. Regardless of the mode of operation used, the IP address of the Muovi probe is 192.168.14.ID, where ID represents the probe's identification number. The subnet mask is fixed and equal to 255.255.255.0. Typing the IP address on any browser will display the internal configuration page (refer to section 8.1.5). The configuration page allows you to check the current settings of the device, the battery level and to change some settings that will be maintained even after turning off the probe. In addition, the OT BioLab+ software provides a button in the configuration window to directly open the Muovi web page.

8.1.2 Signals

The native resolution of the Muovi is 24 bits obtained by sampling the signals with a sigma-delta A/D converter. The signals are acquired coupled with DC and the only existing hardware filtering is a simple 154 kHz antialiasing filter.

The cut-off frequency of the low-pass filter implemented inside the A/D converter is set according to the sampling rate and corresponds to about $\frac{1}{4}$ of the latter. The acquisition with all 24 bits is intended for DC-coupled EEG signals at a maximum sampling rate of 500 Hz. For EMG data collection, a firmware high-pass filter is implemented (only on the bioelectrical signals, thus not on the IMU) that removes the DC component and moves the baseline of the signals to the center of the dynamic. This condition makes it possible to acquire EMG signals with a reduced resolution of 16 bits. The data format in both cases, 24 bit and 16 bit, is big endian.

The filter is implemented by subtracting the exponential moving average from the signals, obtained from:

$$\text{Mean_ChX}[t] = (1-\alpha) \text{Mean_ChX}[t-1] + \alpha \text{ChX}[t]$$

Where α is equal to $1/2^5$. The result is a high-pass filter with a cutoff frequency of 10.5 Hz, when sampling signals at 2000 Hz. More generally, the high-pass cut off frequency is $F_{\text{cutoff}} = F_{\text{sample}}/190$.

Two different sample rates can be set: 500 Hz and 2000 Hz. Choosing the second one automatically sets the high-pass filter and the 16-bit resolution. This mode is designed for EMG signal acquisition. The 500 Hz sampling frequency instead sets the full-DC sampling and the 24 bit resolution, designed for the acquisition of EEG signals.

The A/D converters have differential inputs that allow the positive and negative inputs to theoretically range between ± 2.4 V. In the case of the Muovi, the limit is imposed by the supply voltage, which is 3.3V. The positive input is fed with signals from the electrodes, the negative signals are connected to the patient reference (center point of the power supply). The least significant bit (LSB) of the signals is obtained from:

$$\text{LSB} = \text{ADC}_{\text{RANGE}}/2^{24} = 286.1 \text{ nV}$$

When the 16-bit resolution is set, only the 16 least significant bits are transferred for bioelectric signals and this introduces a limitation in the signal range to 18,75 mV_{pp}.

Table 8.1 summarises the different input ranges, LSB, RMS, and peak-to-peak noise values with the different acquisition settings for bioelectric signals.

Resolution	Input Range	LSB	RMS R.T.I. Noise	P-P R.T.I. Noise
16 bits	18,75 mV	286.1 nV	0.6 – 1.2 μ V	3.6 – 7.8 μ V
24 bits	3,3 V	286.1 nV	0.6 – 1.2 μ V	3.6 – 7.8 μ V

TAB. 8.1. *Characteristics of the signals acquired with different configurations. The range of the noise is related to the different sampling frequencies.*

In addition to the biological signals, there are 4 channels from an inertial sensor and 2 accessory channels. All 6 channels are represented on 16 or 24 bits consistent with the resolution of the bioelectrical signals. In other words, if the acquired bioelectric signals are EMG and the resolution is 16 bit, also the 6 additional channels are represented on 16 bit. Conversely, if the acquired signals are EEG, all channels will be represented at 24 bits, but without altering the contained information, only extending the numbers with a 24-bit representation.

The first four additional channels (channels 33, 34, 35 and 36) are the data related to the IMU (Inertial Measurement Unit) present in each Muovi probe, and corresponding respectively to the W, X, Y and Z quaternions derived from the 3 integrated sensors: accelerometer, gyroscope and magnetometer. The inertial sensor used is the Bosch BNO055 configured in "Fusion Mode - NDOF" with the default measurement ranges and absolute orientation with respect to the gravity vector and magnetic north. The actual resolution of the quaternion data is 14 bits, extended with sign to 16 or 24 bits depending on the acquisition mode of the Muovi probe. The quaternions are the result of an internal calculation within the inertial sensor and are updated at a frequency of 100 Hz, so in the case of sampling at 2000 Hz, there would be 20 samples with the same quaternion values before a new set of values is obtained for the quaternions. In figure 8.1 is shown the IMU sensor placement in the Muovi probe with axis orientation.

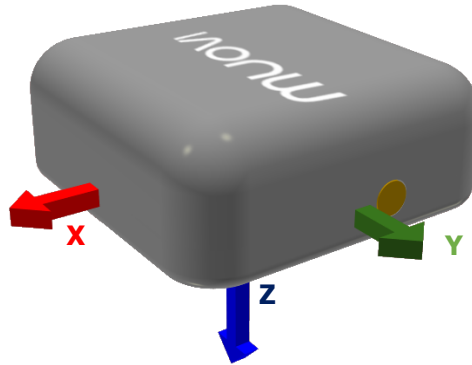

FIG. 8.1: IMU sensor placement and axis orientation.

The two accessory channels contain information related to the RF synchronisation signal sent by the SyncStation, the use of the internal memory buffer of the Muovi probe, and a sample counter. In particular, channel 37 has one bit dedicated to indicate the status of the synchronisation signal, 7 bits indicating the trigger code and 8 bits dedicated to indicate the use of the internal buffer:

Channel 37 (Accessory channel n. 1)											
bit 23	...	bit 16	bit 15	bit 14	bit 13	...	bit 8	bit 7	bit 6	...	Bit 0
0	...	0	TRIG	TR_CODE6	TR_CODE5	...	TR_CODE0	0	BUF6	...	BUF0

- bit 23-16 Not used, fixed at 0. These bits are not present when the resolution is 16 bit.
- bit 15 TRIG: indicates the level of the trigger signal sampled at the same time as the bioelectric signals.
- bit 14-8 TR_CODE <6..0>: Trigger code. It is used to mark each trigger pulse with a code ranging from 1 to 127 to help the offline alignment between the different devices and

the SyncStation. Time for processing the TR_CODE may vary, and the code can appear in a subsequence sample with respect to the sample where the trig pulse is detected.

- bit 7 Not used, fixed at 0.
- bit 6-0 BUF<6:0>: indicator of utilisation of the internal FIFO buffer of Muovi. This value is the percentage of memory bytes occupied by samples previously acquired and not yet sent via WiFi. The maximum size of the FIFO buffer is 190152 bytes.

The second accessory channel (channel 38) is a sample counter. This one is incremented with each new sample acquired and can be used to check if one or more samples have been lost. The difference between two successive values in fact indicates how many samples have passed since the previous sampling and, if some data has been lost, it is possible to identify how many samples have been lost. Once the counter has arrived at the largest possible value with the corresponding resolution, it starts over with the counting.

8.1.3 Acquisition electrodes and patient connection

The Muovi probe connects directly to the acquisition electrodes, so no additional adapters or cables are required. In the case of HD-sEMG signal acquisition, two matrix models are available that can be connected to the Muovi probes:

- HD20MM1602: semi-disposable adhesive matrix with 32 electrodes 16 rows x 2 columns, with an interelectrode distance (IED) of 20mm.
- HD10MM0804: semi-disposable adhesive matrix with 32 electrodes 8 rows x 4 columns with IED 10mm.

On the back of the connector of each matrix there is a rigid tab, which is used to facilitate the insertion and the removal of the matrix from the probe (see Fig. 8.2). The acquisition matrices are defined as semi-reusable because, for their use on a patient, they must be applied by interposing a layer of double-sided die cut foam and conductive cream between the matrix and the skin. The double-sided foam is disposable, while the electrode matrix can be reused, after being cleaned, using a dry cloth, until wear or oxidation of the acquisition electrodes appears.

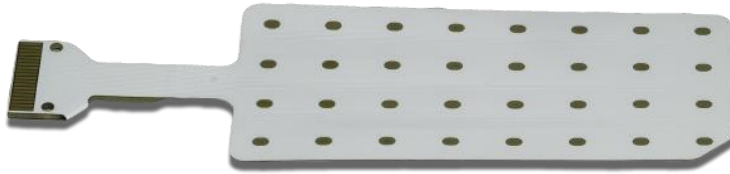

FIG. 8.2: Semi-disposable adhesive matrix HD10MM0804.

Regardless of the acquisition matrix used, the Muovi probe must be connected to the patient with a clamp or reference electrode, this operation is necessary to fix the potential of the patient's body, to the internal reference potential of the Muovi probe, for this purpose, a 2mm female banana connector is available on the probe.

All signals recorded by the Muovi probe are acquired in monopolar mode, with respect to the reference applied to the patient, for this reason it is important that the reference electrode of the patient is positioned on a point without electromyographic activity and possibly close to the electrode for the detection of biopotentials. Differential signals can be obtained via software either on-line or off-line during data processing.

The Muovi probe is designed as a mobile device, for this reason, recharging the battery is done through the same connector used also for the connection of the electrodes, with this solution the simultaneous connection of the patient and the power source during recharging is avoided.

Impedance measurement

Each Muovi probe allows measurement of electrode-to-cute contact impedance, for each connected electrode. The measurement is carried out by alternately connecting 10 Mohm pull-up and pull-down resistors to all inputs of the device and allowing an impedance measurement at $\frac{1}{4}$ of the sampling frequency. The signal generated in this way has an amplitude inversely proportional to that of the electrode skin contact allowing the calculation of the impedance value for each channel.

8.1.4 Recharge of the Muovi probes

Muovi probes can be recharged using their own input/recharge connector whose counterpart is available on the SyncStation base. Up to four probes can be charged simultaneously with the SyncStation base. Muovi probes automatically turn off when they are put on charge. To recharge Muovi probes follow the steps below:

1. Power the SyncStation by plugging in the 12V_{DC} power supply provided in the MuoviPro system KIT
2. When a charging slot on the SyncStation is free, the associated charging LED is off
3. Insert the Muovi probe to be recharged into a free slot. The associated charging LED lights up, indicating that the Muovi probe is charging
4. When charging is complete, the LED will turn off

8.1.5 Wireless data transfer

If one or more Muovi probes are used with the SyncStation, it acts as a hub and receives signals from all devices connected to it, adds data acquired from auxiliary channels, combines all information and forwards it to a PC connected via Ethernet. Communication via Ethernet interface is done using a TCP protocol: a TCP socket is opened on port 54320 to which the PC can connect as a client. By means of a control string, the PC can configure the acquisition and start the data transfer. The data transmitted by the SyncStation appears as coming from a single device with a number of channels equal to the sum of all active channels of all connected probes and all IMUs and accessory/auxiliary channels.

In the case in which the communication is direct between the Muovi probe and PC, the network is generated by the Muovi probe (refer to paragraph 8.1.1) but it is the PC (or tablet, smartphone) that has to open a TCP socket with the role of server to which the Muovi probe will try to connect. The probe, in fact, knows the IP address of the PC as it has been assigned by the probe itself with the DHCP protocol. Once the TCP connection is established, it is possible to send the control byte to the probe to configure the acquisition and start the data transfer.

Regardless of the type of acquisition (direct or via the SyncStation), the data is buffered inside the probe and is sent in packets of about 1400 bytes as soon as possible. If the PC is not able to receive data or if the WiFi connection does not allow it, the data will start to accumulate inside the buffers until the buffer is full. If this condition occurs the data will be lost until the PC and the WiFi connection are available for transfer again.

8.1.6 Muovi internal web page

The Muovi probe has an internal web page that allows you to view and change certain settings. To reach the web page, you must be connected to the Muovi probe or the SyncStation network. The PC's IP

address and subnet mask must be in the same range as those of the Muovi probe or SyncStation. The internal web page can be opened by typing the IP address of the Muovi probe in the address bar of any browser.

The IP address is composed of a first fixed part which is the same for all the Muovi, Muovi+, Due+, Quattro+ probes: 192.168.14.X, while the X reflects the probe ID.

Table 8.2 shows the details and correspondences between the different probes, their IDs and IP addresses.

Alternatively, the OT BioLab+ software can be used to reach the web page. When the Muovi probe is set up as a Device, a "WebPage" button is available in the OT BioLab+ SW that can be accessed from Setup by selecting the Muovi device in the list.

When the Muovi probe is connected directly to the PC the access to the web page is direct. When the probes are connected to the SyncStation and the PC is connected through an ethernet cable, the SyncStation acts as a bridge between the network to which the PC is connected and the network to which the probes are connected. However, it is necessary to inform the PC on which you are trying to open the web page that the address you are looking for must be reached via a bridge. This can be done by modifying the routing table of the PC and informing the operating system that the address range 192.168.14.X can be reached through the address 192.168.76.1.

The page has different sections, and each section has an information area in the lower right corner. Moving the mouse cursor over this area will display an explanation of the corresponding section. A description of each section of the web page follows. Figure 8.3 shows an example of a Muovi web page.

IP address	Device	ID	Serial number	Notes
192.168.14.1	Muovi	1	MVXXX-1	The Muovi probes have a fixed IP address obtained on the basis of serial number and ID.
192.168.14.2		2	MVXXX-2	
192.168.14.3		3	MVXXX-3	
192.168.14.4		4	MVXXX-4	
192.168.14.5	Muovi+	5	MPXXX-5	One or both Muovi+ probes can be replaced by the Sessantaquattro and Sessantaquattro+ devices. Just configure them via their internal web page.
192.168.14.6		6	MPXXX-6	
192.168.14.7	Due+	7	DPXXX-7	The Due+ probes have a fixed IP address obtained on the basis of serial number and ID.
192.168.14.8		8	DPXXX-8	
192.168.14.9		9	DPXXX-9	
192.168.14.10		10	DPXXX-10	
192.168.14.11		11	DPXXX-11	
192.168.14.12		12	DPXXX-12	
192.168.14.13		13	DPXXX-13	
192.168.14.14		14	DPXXX-14	
192.168.14.15	Quattro+	15	QPXXX-15	The Quattro+ probes have a fixed IP address obtained on the basis of serial number and ID.
192.168.14.16		16	QPXXX-16	

TAB. 8.2: Match between IP addresses, probe types, IDs and serial numbers.



muovi

<div style="background-color: #444; color: white; padding: 2px; font-weight: bold; text-align: center;">General Informations</div> <p>Serial Number: MV017-3 MAC address: 98:84:E3:4F:C8:29 Firmware Version: 3.2.1 Battery Level: 93%</p> <p style="text-align: right; font-size: small;">info</p>	<div style="background-color: #444; color: white; padding: 2px; font-weight: bold; text-align: center;">Network settings</div> <p>DHCP Client: Disabled IP Address: 192.168.14.3 Subnet Mask: 255.255.255.0 Default Gateway: 192.168.14.100 DNS Server: 192.168.14.100 Server IP Addr: 192.168.14.17 Server TCP Port: 54321</p> <p style="text-align: right; font-size: small;">info</p>
<div style="background-color: #444; color: white; padding: 2px; font-weight: bold; text-align: center;">General settings</div> <p>Auto shutdown: 30 minutes <input type="button" value="v"/> Always start as AP: No <input type="button" value="v"/></p> <p style="text-align: center;"><input type="button" value="Apply"/></p> <p style="text-align: right; font-size: small;">info</p>	<div style="background-color: #444; color: white; padding: 2px; font-weight: bold; text-align: center;">Firmware Upgrade</div> <p style="font-size: x-small; color: #ccc;">The firmware cannot be updated if muovi has been started temporarily as Access Point. To upgrade the firmware, connect the muovi to the SyncStation or set the "Always Access Point" option and restart the muovi.</p> <p style="text-align: right;">Firmware Upgrade</p> <p style="text-align: right; font-size: x-small;">info</p>

FIG. 8.3: Muovi internal web page.

General Information

This section provides information that cannot be changed: serial number, MAC address, firmware version and battery level. To update the battery indicator you need to refresh the web page.

General Settings

It allows you to select the auto power off of the probe between: never, 15 minutes, 30 minutes or 1 hour.

It allows you to set as default the access point mode for the direct connection of the Muovi probe with the PC. Normally the Muovi probes try to connect to the SyncStation, but if the button is pressed for more than 5 seconds (see paragraph 8.1.1) the probe creates its own WiFi network. It is possible to

make this mode the default one so that the probe will always start in this mode regardless of how long the button is pressed.

Network information

This section shows information about the Muovi's network that cannot be changed.

Firmware upgrade

A firmware update of Muovi is possible by uploading a compressed file containing the firmware itself. Pressing the button will open a new page with instructions on how to proceed and will show the progress of the process. In a first step the file will be loaded into the flash memory of the Muovi and the files will be extracted from the compressed file. Afterwards, the Muovi will automatically reboot trying to start with the new firmware and connect back to the PC. If this does not happen the loaded file will be discarded, and the firmware will revert to the previous one. It is important that the battery level of the device is not too low during the firmware update and that it allows you to finish the procedure.

8.1.7 Probe Nomenclature

In order to help identify the Muovi probes, understand their role within the MuoviPro system, and allow you to reach the internal web page, each probe's serial number consists of a three-part code:

MV123-4

Where:

- "MV": are the letters that identify the type of device (MV = Muovi, MP = Muovi+, DP = Due+, QP = Quattro+)
- "123": standard numbers to all devices belonging to the same system (from 000 to 999)

- "4": a number that represents the probe ID and corresponds to the last part of the probe IP address. The IP address of all wireless devices is 192.168.14.X where X is the probe ID. So, for the example mentioned, the IP address is: 192.168.14.4.

Refer to the table 8.2 for details about IP addresses and correspondence with probe IDs and serial numbers.

8.2 Use of the SyncStation

8.2.1 SyncStation network interface

The SyncStation is used both for charging Muovi probes and for simultaneous data transfer of multiple Muovi probes and/or other devices to the PC. The main function of the SyncStation is to act as a data concentrator from a WiFi access point, which accepts connections from wireless devices to a PC, via an Ethernet interface. You can simultaneously connect to the SyncStation:

- up to four Muovi probes;
- up to two Muovi+ or two Sessantaquattro or two Sessantaquattro+ probes;
- up to eight Due+ probes;
- up to two Quattro+ probes.

To the signals coming from the connected wireless devices must be added four auxiliary signals acquired from the connectors on the SyncStation and two accessory channels with information on the status of the Trigger, the status of the internal buffer and a sample counter. The 6 auxiliary/accessory channels are then added to all the data received from the connected devices and all the data is handled to appear on the PC connected to the SyncStation Ethernet socket as a single stream of multiplexed samples from a single device with a number of channels equal to the sum of the managed channels. The SyncStation therefore has two different network interfaces, the details of which are given in Table 8.3.

	Network to wireless device	Network to the PC
Description	Hidden WiFi dedicated exclusively to the connection of wireless devices Muovi, Muovi+, Due+, Sessantaquattro, Sessantaquattro+ and Quattro+	Ethernet to the PC for acquisition data
IP SyncStation	192.168.14.100	192.168.76.1
IP connected devices	192.168.14.1 – 192.168.14.16 IP fixed wireless devices	192.168.76.X fixed to PC with DHCP
TCP socket SyncStation	54321 – SyncStation server TCP	54320 – SyncStation server TCP

TAB. 8.3: Details of two SyncStation network interfaces

8.2.2 Data transfer to PC

On both interfaces a TCP socket server is opened which allows the connection of the various wireless devices on one side and the PC on the other. Once the connections are established through the TCP sockets, the SyncStation receives a control string from the PC, sorts the commands to the different connected wireless devices and starts receiving data from the probes and forwarding them to the PC. The data received from the probes arrives in packets with sizes that depend on the probe type and configuration (see Tables 8.4 - 8.8). Data sent to the PC is sent out in packets that depend on the configuration of the probes. The output packets contain samples from all active channels for a duration equal to the lower sending interval of the active wireless devices. This packet of outgoing data is defined as an output packet for the PC.

For each connected and configured device, and for the auxiliary inputs, the SyncStation allocates a certain amount of memory as input buffer, such that 32 WiFi packets per probe are stored. The received data is temporarily written to the respective input buffers waiting to be processed and copied to an output buffer. When the entire output packet for the PC is available within the output buffer, it is sent to the PC. If data from some devices is not received within a maximum time limit, the output packet for the PC is still sent by inserting values of 0 into the samples of the missing device. Figure 8.4 graphically describes the handling of input and output packets.

The output buffer can hold up to 210 output packets of all channels and all connected devices. The maximum limit for sending data to the PC, even in the absence of data from all probes, is by default 200 output packets accumulated in the buffer. These samples are scanned by the sampling of the AUX signals inside the SyncStation.

It should be noted that not necessarily a "hole" between the data shown in real time during the signal acquisition represents a real loss of data. The data may simply be temporarily unavailable but still saved in the internal buffers of the probes and sent later.

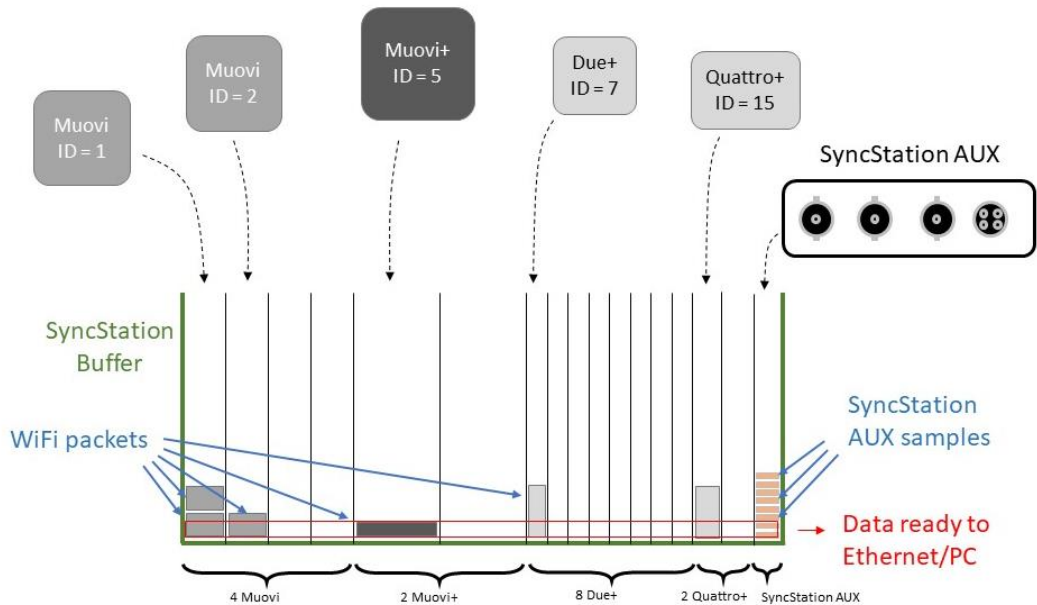

FIG. 8.4: Simplified graphical representation of data handling by the SyncStation: packets received via WiFi from the various active probes is accumulated in FIFO buffers as well as samples acquired from the auxiliary channels. When a minimum number of samples from all active devices are available, an output packet for the PC containing samples from all devices is sent via Ethernet to the PC. An internal timer determines a maximum time limit within which the send condition can occur. In case it does not occur in time due to non-received packets from one or more probes (probes unavailable, delayed, not connected etc...), the missing data is replaced with zeros.

If some probes are configured to acquire EMG signals and others to acquire EEG signals, the SyncStation performs 3 replications of the EEG samples to obtain all the data sampled with the highest sampling frequency, that is 2000 Hz.

Even if all the connected probes are configured to acquire EEG signals (Sampling Frequency 500 Hz), the auxiliary and accessory channels of the SyncStation will be sampled at 2000Hz and all the EEG samples are replicated 3 times to preserve the 2000 Hz sampling frequency on all the channels.

In any case, the samples obtained from probes configured as EMG will be on 16 bit, the samples obtained from probes configured as EEG will be on 24 bit, the samples obtained from the auxiliary and accessory channels of the SyncStation will be on 16 bit. In case you intend to develop your own software/application to read the data this aspect must be managed within the software/application.

Further technical details describing the data accumulation system and subsequent sending to the PC are given in Tables 8.4, 8.5, 8.6, 8.7 and 8.8.

Muovi		
Mode	Parameters	Value
-	Muovi probe channels	32 bioelectrical + 4 IMU + 2 Accessories
EMG	Sampling frequency	2000 Hz
	Resolution	16 bit
	Sample dimension	76 byte
	Sample number in each WiFi packet	18
	WiFi packet dimension	1368 byte
	Interval for sending WiFi packets	9 ms
	Buffer size in the SyncStation for a Muovi probe	87552 byte
EEG	Sampling frequency	500 Hz
	Resolution	24 bit
	Sample dimension	114 byte
	Sample number in each WiFi packet	12
	WiFi packet dimension	1368 byte
	Interval for sending WiFi packets	24 ms
	Buffer size in the SyncStation for a Muovi probe	87552 byte

TAB. 8.4: Technical data of Muovi probe in EEG and EMG acquisition mode

Muovi+ / Sessantaquattro / Sessantaquattro+		
Mode	Parameters	Value
-	Muovi+ probe channels	64 bioelectrical + 4 IMU + 2 Accessories
	Sessantaquattro+ channels	64 bioelectrical + 4 IMU + 2 Accessories
	Sessantaquattro channels	64 bioelectrical + 2 AUX + 2 Unused + 2 Accessories
EMG	Sampling frequency	2000 Hz
	Resolution	16 bit
	Sample dimension	140 byte
	Sample number in each WiFi packet	10
	WiFi packet dimension	1400 byte
	Interval for sending WiFi packets	5 ms
	Buffer size in the SyncStation	89600 byte
EEG	Sampling frequency	500 Hz
	Resolution	24 bit
	Sample dimension	210 byte
	Sample number in each WiFi packet	6
	WiFi packet dimension	1260 byte
	Interval for sending WiFi packets	12 ms
	Buffer size in the SyncStation	80640 byte

TAB. 8.5: Technical data of Muovi+ probe, Sessantaquattro, Sessantaquattro+ in EMG and EEG acquisition mode. In the case of Sessantaquattro and Sessantaquattro+ two channels are added with the samples always at 0 to obtain the same number of channels as the Muovi+ and to be completely interchangeable with the Muovi+ probes

Due+		
Mode	Parameters	Value
-	Due+ probe channels	2 bioelectrical + 4 IMU + 2 Accessories
EMG	Sampling frequency	2000 Hz
	Resolution	16 bit
	Sample dimension	16 byte
	Sample number in each WiFi packet	54
	WiFi packet dimension	864 byte
	Interval for sending WiFi packets	27 ms
	Buffer size in the SyncStation for a Due+ probe	55296 byte

TAB. 8.6: Technical data of Due+ probe

Quattro+		
Mode	Parameters	Value
-	Quattro+ probe channels	4 bioelectrical + 4 IMU + 2 Accessories
EMG	Sampling frequency	2000 Hz
	Resolution	16 bit
	Sample dimension	16 byte
	Sample number in each WiFi packet	43
	WiFi packet dimension	860 byte
	Interval for sending WiFi packets	21.5 ms
	Buffer size in the SyncStation for a Quattro+ probe	55040 byte

***TAB. 8.7:** Technical data of Quattro+ probe*

SyncStation AUX/accessories channels		
Mode	Parameters	Value
-	SyncStation channels	4 AUX + 2 Accessories
	Sampling frequency	2000 Hz
	Resolution	16 bit
	Sample dimension	12 byte

***TAB. 8.8:** Technical data relating to the auxiliary and accessory channels of the SyncStation. The sampling frequency of the channels in the SyncStation is by default equal to 2000 Hz, it drops to 500 Hz if all the probes used are configured for the acquisition of EEG signals.*

In line with all the channels of the active wireless sources, the SyncStation adds four auxiliary channels and two accessory channels. These are always 16-bit resolution. The four auxiliary channels of the SyncStation report the samples obtained from the analog/digital conversion of the corresponding auxiliary inputs, therefore the channel dedicated to the load cell is the fourth auxiliary channel. At the end of the four auxiliary channels there are, as for the Muovi+ probe, two accessory channels. Also, in this case the OT BioLab+ software does not display these channels but acquires them and it is possible to view them afterwards to verify the presence of all the samples.

The two accessory channels contain information relating to the RF synchronisation signal generated by the SyncStation (present on the "SYNC" BNC), the use of the memory buffer inside the Muovi probe and a sample counter. In particular, the first accessory channel has a dedicated bit to indicate the status of the synchronisation signal, 7 bits indicating the trigger code and 8 bits dedicated to indicate the use of the internal buffer:

Accessory channel SyncStation n. 1								
bit 15	bit 14	bit 13	...	bit 8	bit 7	bit 6	...	bit 0
TRIG	TR_CODE6	TR_CODE5	...	TR_CODE0	BUF7	BUF6	...	BUF0

- bit 15 TRIG: represents the level of the trigger signal sampled at the same time as the bioelectrical signals.
- bit 14-8 TR_CODE <6..0>: Trigger code. It is used to mark each trigger pulse with a code ranging from 1 to 127 to help the offline alignment between the different devices and the SyncStation. Time for processing the TR_CODE may vary, and the code can appear in a subsequence sample with respect to the sample where the trig pulse is detected.
- bit 7-0 BUF <7:0>: indicator of use of the FIFO buffer inside the SyncStation. This value indicates how many output packets waiting to be sent to the PC are present in the SyncStation. Failure to send is caused by missing or not yet received data from a wireless probe. The maximum number of backward output packets is 200, after which the pending data are sent anyway. This value can be reduced by changing the configuration of the SyncStation.

The second accessory channel is a sample counter. This is incremented with each new sample acquired from the accessory inputs and can be used to check if one or more samples have been lost. The difference between two successive values in fact indicates how many samples have elapsed since the previous sampling and if some data have been lost, it is possible to identify how many samples have been lost. Once the counter reaches 65535, it restarts from 0 with the count.

8.2.3 SyncStation internal web page

The SyncStation base has an internal web page that allows you to view and change certain settings. To reach the web page, you must be connected to the SyncStation with a PC via an Ethernet cable. The PC IP address and subnet mask must be in the same range as those of the SyncStation. The internal web page can be opened by typing the IP address of the SyncStation into the address bar of any browser. The IP address is fixed and is 192.168.76.1.

Through the web page the firmware of the SyncStation can be updated and the WiFi channels can be set, and the application can be restarted.

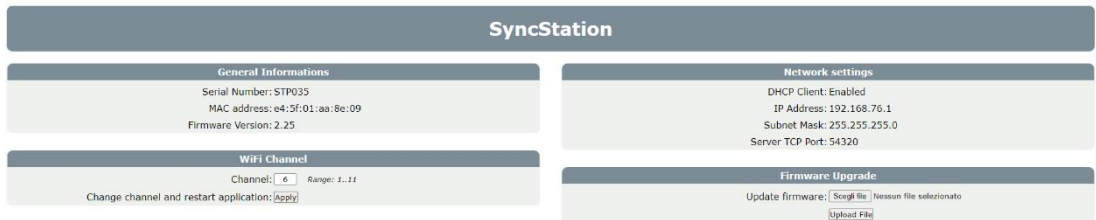

FIG. 8.5: SyncStation internal web page

General Information

This section provides information that cannot be changed: serial number, MAC address, firmware version and the possibility to update the firmware. SyncStation firmware update is possible by uploading a file containing the firmware itself. By pressing the "Browse..." button you can browse your PC and choose a file to upload. Once the file is selected, by pressing the "Upload File" button the SyncStation firmware execution will be blocked, and the file will be replaced with the previous one. In order to run the new firmware, it is necessary to restart the SyncStation.

Network Settings

This section shows the network information of the SyncStation that cannot be changed.

WiFi channel

This section may be useful if you are unable to obtain a stable communication between your PC and SyncStation. In fact, if the Wifi channel to which the SyncStation is connected is saturated, unstable communication could occur. The most used channels to obtain maximum throughput and minimize the effects of interference are generally channels 1, 6 and 11.

This section can also be used for a simple reboot of the SyncStation.

Firmware update

A firmware update of SyncStation is possible by uploading a file containing the firmware itself. Pressing the button will open a new page showing the progress of the process. Afterwards, the SyncStation will automatically reboot, trying to start with the new firmware and return to connection with the PC. If this does not happen, the loaded file will be discarded and the firmware will revert to the previous one.

9 TROUBLESHOOTING

This section describes the most common problems that may be found by MuoviPro users, with some suggestions to solve them. For problems not described in this section contact the technical support team of OT Bioelettronica.

GENERAL PROBLEMS		
Problem	Possible cause	Solution
The Muovi does not turn on	The battery level is too low.	Leave the device charging for at least one hour.
	If a firmware update had just been performed, something wrong might have happened.	Contact OT Bioelettronica.
The embedded web page is not displayed at the expected IP address	The PC is not connected to the same network as the Muovi or they are not in the same address range.	Check that the connection is on the same network and check the network card settings on the PC.
	The expected IP address may be wrong.	Use OT BioLab+ to reach the Muovi web page
The device shows some flat signals (with all values equal to 0).	Absence of conductive cream on some of the electrodes.	Check that there is conductive cream on all electrodes and remake the setup if necessary.
	The signals are present but saturated for a higher DC component.	In the Preamp Gain section of the setup (OTBiolab+ software) select the value 4. In this way the signals will be part of the dynamics, but the noise will increase slightly. Warning: this process modifies also the LSB.

TAB. 9.1: Troubleshooting of the general problems that can occur using the MuoviPro.

10 MUOVIPRO MAINTENANCE AND STORAGE

MuoviPro has to be used in the following conditions:

Temperature:	from 0°C to +40°C
Maximum relative humidity:	75%
Atmospheric pressure:	from 700 hPa to 1060 hPa

It is recommended to turn off the MuoviPro system at the end of each measurement session, and to remove all connections. The MuoviPro system should be stored with all the enclosed accessories on a safe desk far from all the situations listed in the section *Warnings*.

MuoviPro should be stored in the following conditions:

Temperature:	from –20°C to +40°C
Maximum relative humidity:	75%
Atmospheric pressure:	from 700 hPa to 1060 hPa

Cleaning: use only a dry cloth to clean the device.

It is recommended to plan a device check every 24 months with the manufacturer. The MuoviPro system should be repaired by the manufacturer only. Every repair executed by unauthorised personnel will be considered as a device violation that voids the manufacturer's warranty.

Disposal

The system and the accessories should be disposed of in compliance with the relative standards in special equipped areas or with special waste.

The MuoviPro device contains electronic components that must be disposed of as electronic waste. Dispose of the device and accessories according to local regulations. Follow the regulations regarding the disposal of your country to ensure the correct disposal of MuoviPro and its accessories. For more information on disposal of this device, contact the Environment Department and local authorities.



Warning: Do not dispose of this product as unsorted municipal waste. Collection of such waste separately for special treatment of the necessary, following Directive 2002/96/EC of the European Parliament and of the European Council on waste Electrical and Electronic Equipment (WEEE). The regulation is not valid in case of damaged product.

Lifespan of the device

The MuoviPro system is manufactured to last if the use and maintenance conditions indicated in this User Manual are followed. The lifespan of the device is determined by the battery life (5 years). After this period, it is advisable to bring the device to the manufacturer every two years.

11 RISK ANALYSIS

11.1 General requirement for basic safety and essential performance CEI EN 60601-1-2

- EN 60601-1 Medical electrical equipment - Part 1: General safety requirement
- EN 60601-1-2 Medical electrical equipment - Part 1: General requirement for basic safety and essential performance
- ETSI EN 301 489-1 ElectroMagnetic Compatibility (EMC) standard for radio equipment and services - Part 1: Common technical requirements; Harmonised Standard for ElectroMagnetic Compatibility

MuoviPro is designed to be used in an electromagnetic environment with the characteristics specified below. The purchaser or user of MuoviPro is obliged to ensure that the device is used in an environment that complies with these specifications.

Manufacturer's declaration and guidelines – electromagnetic emissions	
EN 60601-1-2 and ETSI EN 301 489-1	
Phenomenon	Professional healthcare environment
RF conducted and radiated emissions	EN 55011:2009 + A1:2010
	EN 55032:2015
RF conducted and radiated emissions	IEC 61000-3-3

TAB. 11.1: Tests carried out and passed for compliance with current regulations on electromagnetic emissions.

Manufacturer's declaration and guidelines – electromagnetic immunity – casing door		
Phenomenon	EMC reference standard or test method	Immunity test levels - Professional healthcare environment
EN 60601-1-2, EN 60601-2-40 and ETSI EN 301 489-1		
Electrostatic discharges	IEC 61000-4-2	+/- 8 kV contact +/- 2 kV, +/- 4 kV, +/- 8 kV, +/- 15 kV in air
Radiated RF EM fields	IEC 61000-4-3	3 V/m 80 MHz – 2.7 GHz 80% AM a 1 kHz
Radiated RF EM fields and proximity wireless fields	IEC 61000-4-3	28 V/m 450 MHz, 810 MHz - 2.45 GHz at 217 Hz 27 V/m 385 MHz at 18 Hz 9 V/m 710 MHz – 780 MHz, 5.24 GHz – 5.785 GHz at 217 Hz
Electrical fast transient and bursts	IEC 61000-4-4	+/- 2 kV at 100 kHz on power supply +/- 1 kV at 5 kHz on power supply
Surges	IEC 61000-4-5	500 V and 1 kV line to line 500 V, 1 kV and 2 kV line to ground
Conducted disturbances induced by RF fields	IEC 61000-4-6	3 V RMS outside ISM band 80% AM at 1 kHz 6 V RMS in ISM band 80% AM at 1 kHz
Voltage variation and dips	IEC 61000-4-11	V supply: 100 V AC, 240 V AC and 230 V AC with DIP pattern: 0V – 10ms; 0V – 20ms; 0.7 Un – 500ms; 0V – 5s Testing on power supply
Rated power-frequency magnetic fields	IEC 61000-4-8	30 A/m - 50 Hz

TAB. 11.2: Tests carried out and passed for compliance with current regulations on electromagnetic immunity.

12 INTENDED USE

MuoviPro is a medical device intended for the study of the biomechanics of movement and the acquisition of bioelectrical signals from the neuromuscular system.

The clinical applications of the system are in the context of:

- neurological rehabilitation
- prosthetic

Neurological rehabilitation

- The device allows you to obtain the so-called Bio-feedback, or visual or auditory feedback, which helps the physiotherapist in teaching the patient to contract or relax the target muscles. Condition that is necessary following lesions of the central nervous system or to counteract the difficulty in recruiting certain muscle groups due to prolonged immobility.

Prosthetics

- The device allows you to identify the areas in which the electromyographic signal is most intense, in order to determine the positioning of the electrodes of the active prostheses.

13 TECHNICAL CHARACTERISTICS

<i>Model:</i>	MuoviPro
<i>Risk Class:</i>	I in compliance with the Regulation MDR 2017/745.
<i>Insulation Class:</i>	BF type with applied parts, in compliance with the European standard EN 60601-1
<i>Basic UDI:</i>	805697785PORTABLEEMG002SF
<i>Classification:</i>	IP20, based on liquids' and dust's penetration; unprotected device.
<i>Case:</i>	<i>Painted ABS</i>
<i>Power supply:</i>	Internal Rechargeable Li-Po battery 3.7 V
<i>Consumption:</i>	0.6 W
<i>Limitations:</i>	The device is not suitable for use in environments with high oxygen concentration and/or flammable fluids and/or gases; do not use with electro-surgery or short wave/microwave therapy equipment.
<i>Working conditions:</i>	Device suitable for continuative work.
<i>Input channels:</i>	158 independents: 128 biopotential signals, 16 quaternions, 4 auxiliary channels, 10 control channels.
<i>Input range:</i>	0 – 3.3 V for biopotential signals, ± 5 V for auxiliary signals.
<i>Noise Referred to the Input:</i>	$< 6 \mu\text{V}_{\text{RMS}}$
<i>Bandwidth:</i>	DC ÷ 500 Hz
<i>Signal gain:</i>	1 V/V for biopotential signals, 0.5 V/V for auxiliary signals.
<i>Resolution:</i>	16/24 bits
<i>Input resistance:</i>	500 M Ω
<i>Commands:</i>	1 pushbutton x Device
<i>Dimensions:</i>	Probe: 40 x 40 x 17 mm SyncStation: 178 x 178 x 29 mm
<i>Weight:</i>	Probe: 38g System: 725 g

14 WARRANTY

MuoviPro electronic parts are covered by a 24-month warranty starting from the purchasing date.

Connection cables are covered by a 24-month warranty.

The warranty is void in case of device violation or in case of intervention from unauthorised staff.

Warranty conditions are reported hereinafter.

14.1 Warranty conditions

1. The electronic parts warranty lasts 24 months. Warranty is provided by the manufacturer.
2. The warranty covers only device damage that causes malfunctioning. The product must have the same serial number indicated on this certificate, or the warranty is invalid.
3. The warranty covers only the cost of repair or substitutions of defective components, including the costs of labour.
4. The warranty is void in case of damage caused by negligence, use not compliant with the instructions supplied, unauthorised repairs and accidental circumstances, especially for the external part.
5. The warranty is void if damage is caused by incorrect power supply.
6. The warranty is not applied on all the parts subject to wear and tear.
7. The warranty does not include the shipment costs.
8. After 24 months, the warranty is released. All the substituted parts, the labour costs and the shipment costs will be charged to the purchaser according to the rates in force.

Designed and produced by:

OT Bioelettronica s.r.l.

Via San Marino 21

10134 – Torino (TO) - ITALY

Tel: +39.011.19720518

Fax: +39.011.19720519

www.otbioelettronica.it

mail@otbioelettronica.it